BIG TEN STUDENT DESIGN CHALLENGE

Ballantine Burrow

CCJR

Cortney, Claire, Julianna, Rachel

AUTONOMY

FREEDOM

CONVENIENCE

EXISTING SPACE

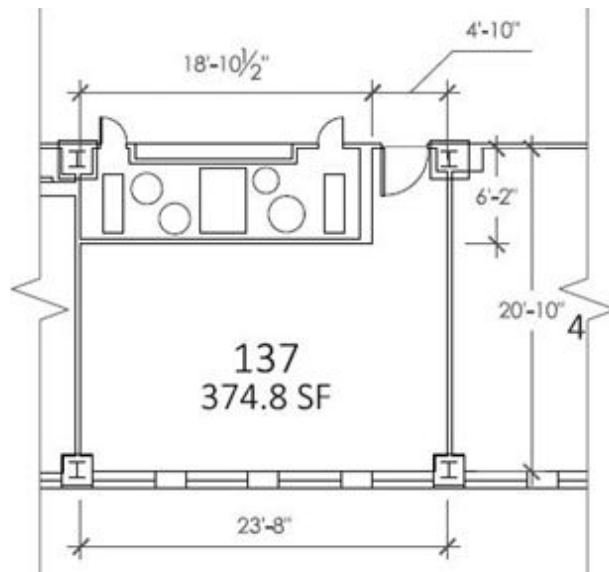

ORIGINAL DESIGN

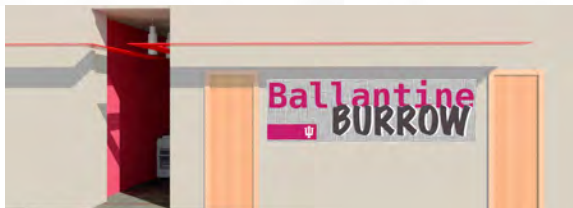
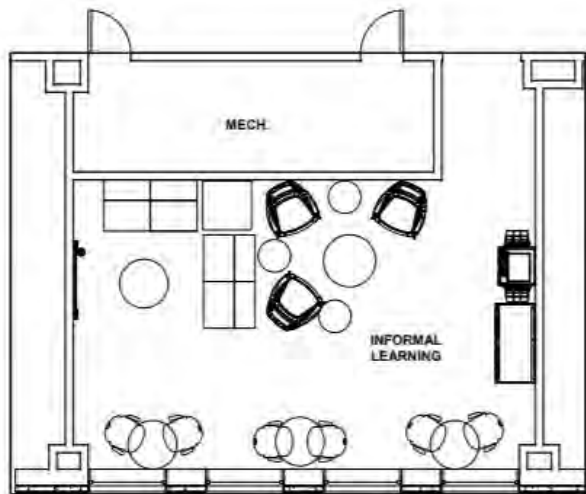

REVISED DESIGN

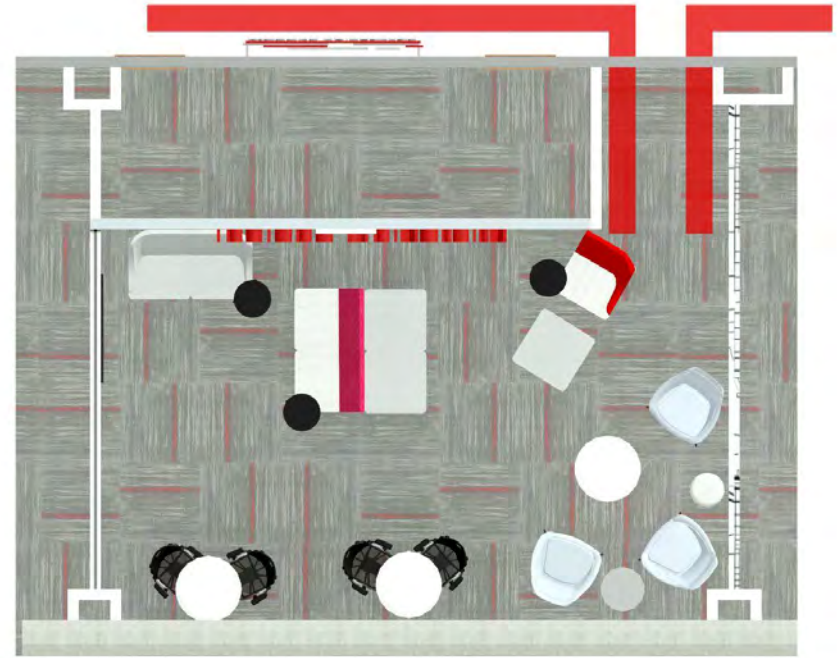
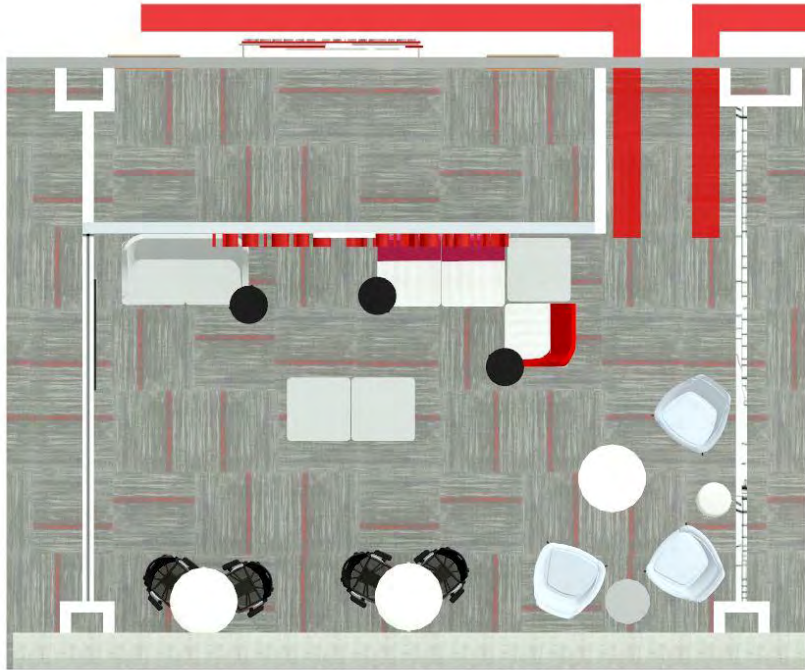

REVISED DESIGN







MATERIAL SELECTION

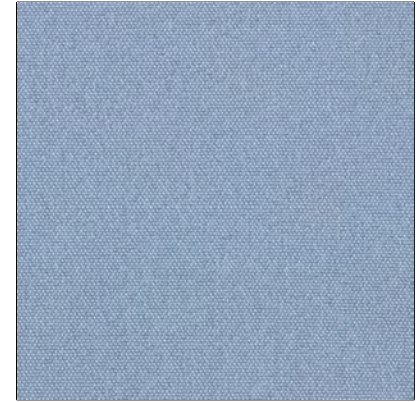
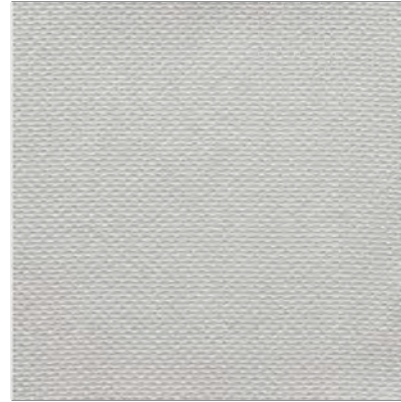
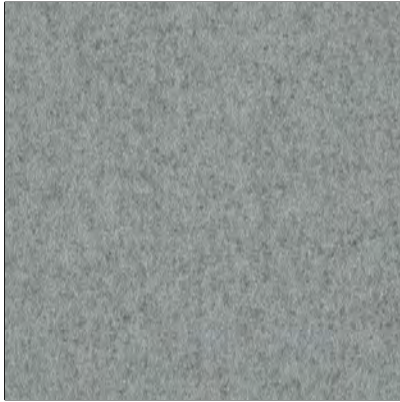

HOW WE HAVE GROWN

PURPOSEFUL DESIGN

SPECIFIC INTENTION

LOGISTICS

COLLABORATION FOR EFFECTIVE DESIGN
